

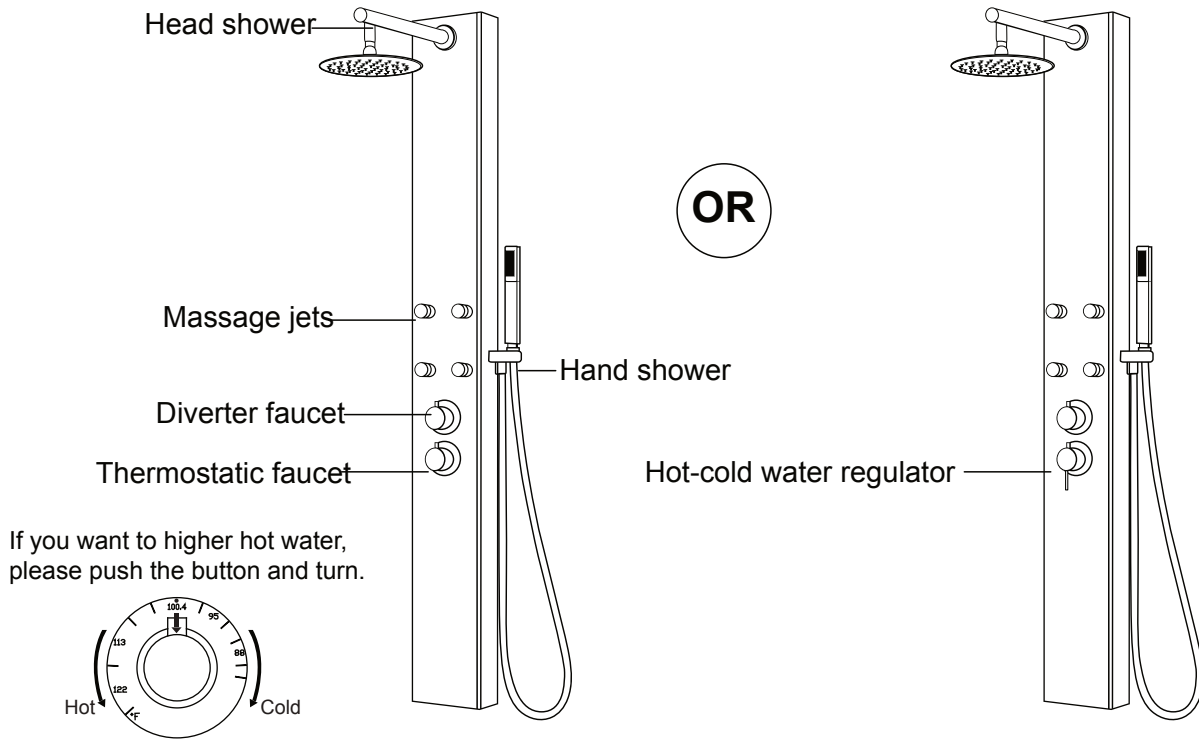

# INSTALLATION INSTRUCTIONS FOR SHOWER COLUMN

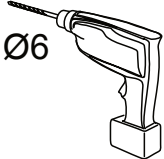

**Note: Installation is the same**

## FOR INSTALLATION YOU MAY REQUIRE

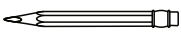
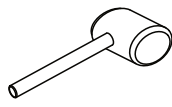
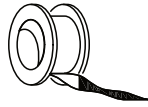
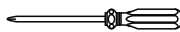
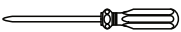
			
Electric Drill	Tape	Wrenches	Pencil
			
Hammer	Sealing Tape	Screwdriver	Screwdriver



# INSTALLATION INSTRUCTIONS FOR SHOWER COLUMN

Note: Always check the walls for pipes and wires before drilling.

## Steps:

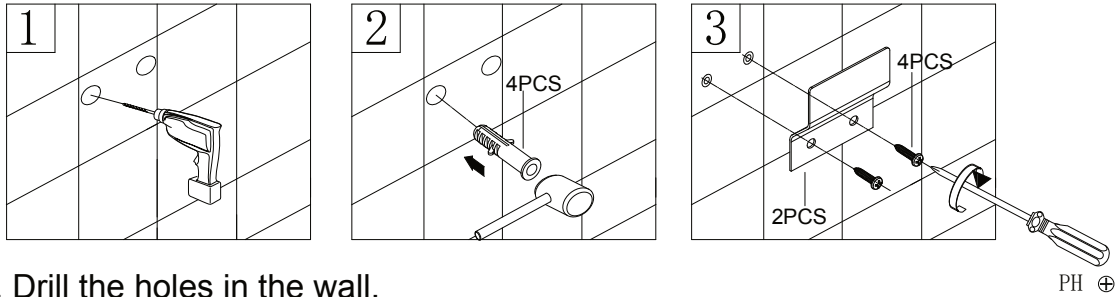

1. Drill the holes in the wall.
2. Insert the wall plugs inside the holes.
3. Tighten the screws to the wall with wall mounting brackets.

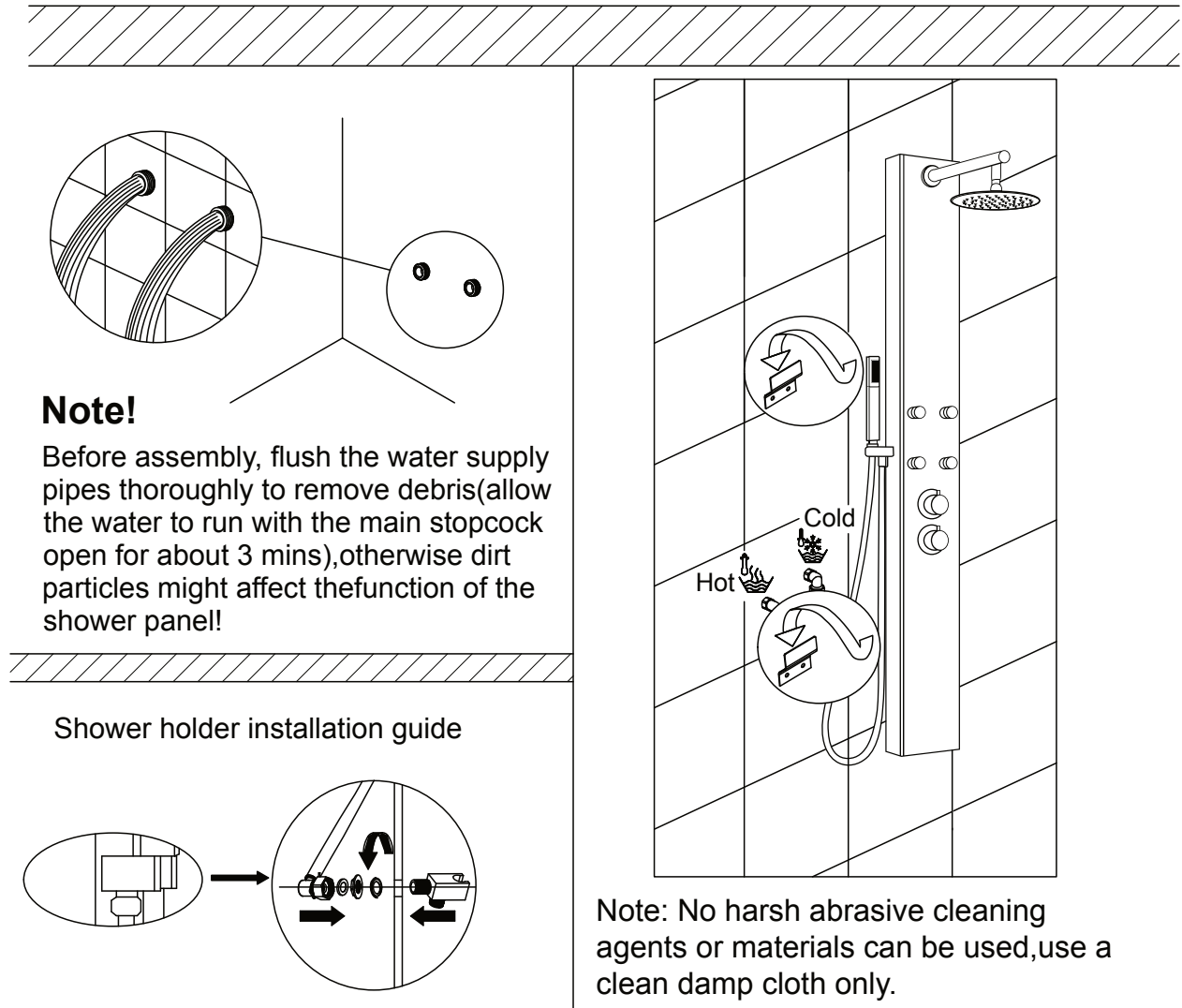

### Note!

Before assembly, flush the water supply pipes thoroughly to remove debris (allow the water to run with the main stopcock open for about 3 mins), otherwise dirt particles might affect the function of the shower panel!

### Shower holder installation guide

Note: No harsh abrasive cleaning agents or materials can be used, use a clean damp cloth only.





**NOTE: PLEASE CARRY OUT THE FOLLOWING STEPS, IF CLEANING /MAINTENANCE IS REQUIRED.**

## Thermostatic valve removal and installation

### Remove process

① Take off cap

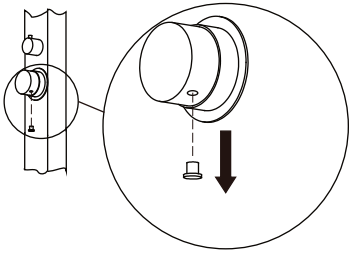

② Loosen HEX screw off with allen wrench

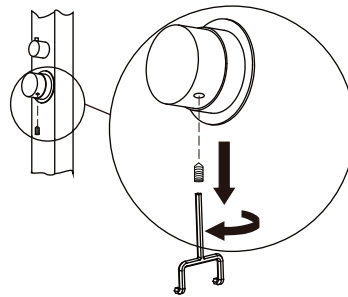

③ Take off head

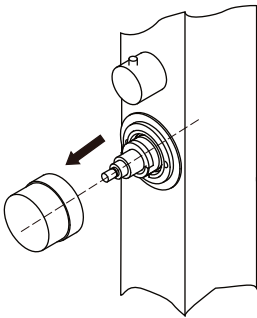

④ Take off ring

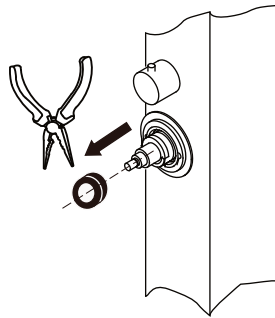

⑤ Unscrew the brass ring from the valve by tool

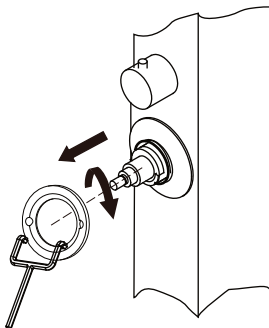

⑥ Remove the valve and clean: Run under warm water and use a toothbrush or similar to remove any debris or limescale

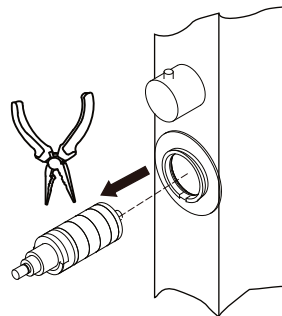

## Installation process

① Put the valve back

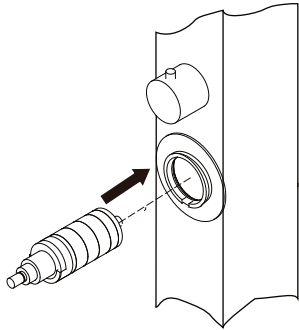

② Put brass ring on top of valve

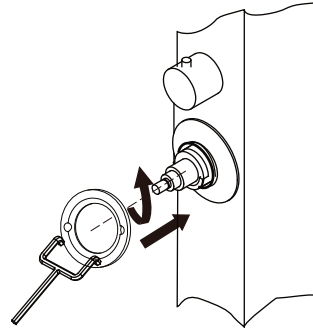

③ Put ring in place

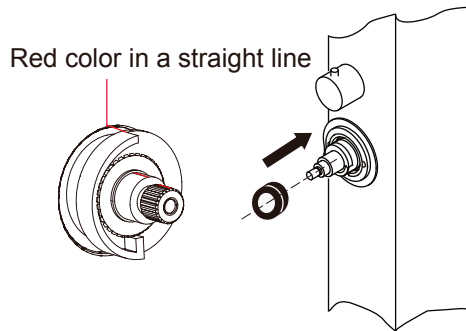

④ Press the button on the head and put on the head as below ensuring the screw hole pointing to the front

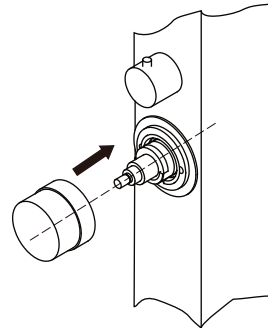

⑤ Use allen key to fix the HEX screw tightly

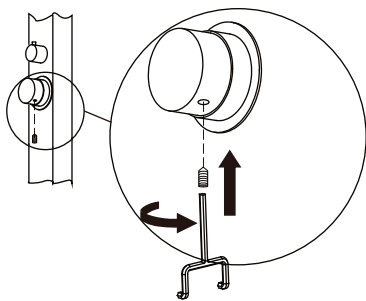

⑥ Put on cap

